

This document is best viewed at a screen resolution of 1024 X 768.

To set your screen resolution do the following:
RIGHT CLICK on the **DESKTOP**.
Select **PROPERTIES**.
CLICK the **SETTINGS TAB**.
MOVE THE SLIDER under **SCREEN RESOLUTION** until it shows **1024 X 768**.
CLICK OK to apply the resolution.

The Bookmarks panel will allow you to quickly navigate to points of interest.

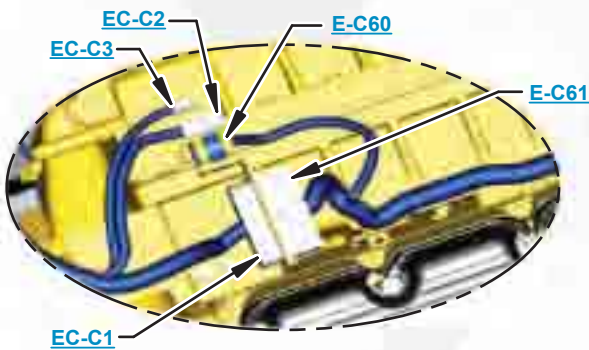

Click on any text that is BLUE and underlined. These are hyperlinks that can be used to navigate the schematic and machine views.

VIEW ALL CALLOUTS

When only one callout is showing on a machine view this button will make all of the callouts visible. This button is located in the top right corner of every machine view page.

HOTKEYS (Keyboard Shortcuts)		
	FUNCTION	KEYS
	Zoom In	"CTRL" / "+"
	Zoom Out	"CTRL" / "-"
	Fit to Page	"CTRL" / "0" (zero)
	Hand Tool	"SPACEBAR" (hold down)
	Find	"CTRL" / "F"



Schematic

950H and 962H Wheel Loader IT62H Integrated Toolcarrier Electrical System

950H:

N1A3213-4214
JAD188-UP
M1G1783-2110
K5K435-2187

962H:

N4A1257-2059
M3G542-678
MAL1-UP
K6K435-516

IT62H:

M5G476-478

Volume 1 of 2: Chassis

Volume 2 of 2: Cab

COMPONENT LOCATION

Volume 1 of 2 - CHASSIS



Component	Schematic Location	Machine Location	Component	Schematic Location	Machine Location
AIH	G-10	1	Sensor - Oil Pressure	E-13	17
Alarm - Backup	H-13	2	Sensor - Rail Pressure	E-13	1
Alternator	I-10	3	Sensor - Rear Axle Oil Temp.	C-9	21
Arc Suppressor - A/C	C-11	3	Sensor - Rotary Lift Position	J-2	22
Arc Suppressor - Quick Coupler	F-1	4	Sensor - Rotary Tilt Position	J-2	23
Arc Suppressor - Secondary Steering	I-8	5	Sensor - Speed Timing Group	D-12	17
Arc Suppressor - Start Relay	H-12	6	Sensor - Trans. Output Speed (Leading)	H-8	24
Batteries	J-10	7	Sensor - Trans. Output Speed (Trailing)	H-8	24
Block Asm.	J-11	7	Sensor - Transmission Input Speed	H-8	25
Breaker - AIH	I-12	6	Sensor - Transmission Oil Temperature	H-8	26
Breaker - Belly Guard Actuator	I-12	6	Sensor - Turbo Inlet Pressure	G-10	27
Breaker - Hood Actuator	I-12	6	Solenoid - A/C Clutch	C-11	3
Breaker - Main	H-12	6	Solenoid - Aux Third Function (Forward)	E-2, H-1	20
Breaker - Running Lamp	I-12	6	Solenoid - Aux Third Function (Rearward)	D-2, H-1	20
Breaker - Start	H-12	6	Solenoid - Axle Cooler Clutch	G-10	1
Breaker - Unswitched Bus (Cab)	I-12	6	Solenoid - Dump Anti-Drift	E-2, H-2	20
Control - Engine	G-12	8	Solenoid - Dump Prop	E-2, H-1	20
Control - Hood Raise/Lower	I-11	6	Solenoid - Lower Anti-Drift	D-2, H-2	20
Motor - Autolube Pump	C-5	9	Solenoid - Lower Prop	E-2, H-1	20
Motor - Belly Guard	J-12	10	Solenoid - Pilot Hydraulic Supply	D-2, G-1	20
Motor - Front Washer	D-5	11	Solenoid - Quick Coupler	F-1	4
Motor - Fuel Priming Pump	C-11	1	Solenoid - Rack Back Prop	E-2, H-1	20
Motor - Hood Actuator	H-13	12	Solenoid - Raise Prop	D-2, G-1	20
Motor - Rear Washer	D-5	11	Solenoid - Ether Aid	E-8	29
Motor - Secondary Steering	I-8	5	Solenoid - Variable Speed Fan	H-9	28
Motor - Starter	I-9	13	Solenoids - Cylinder Head (1 - 6)	F-13	30
Relay - AIH	G-10	1	Solenoids - Ride Control (1-3)	E-2, H-2	20
Relay - Backup	H-14	64	Solenoids - Trans. Clutch	H-8	25
Relay - Main	H-12	6	Switch - A/C Refrigerant	C-11	3
Relay - Secondary Steering Intermediate	I-8	5	Switch - Belly Guard Actuator	J-11	6
Relay - Start	H-12	6	Switch - Brake Oil Pressure	H-10	3
Resistor - CAN	E-8	8	Switch - Bucket Position	G-1	32
Sender - Fuel Level	I-13	14	Switch - Disconnect	J-10	6
Sender - T/C Temperature	F-8	15	Switch - Fork Position	G-1	32
Sensor - Atmospheric Pressure	E-13	16	Switch - Fuel Pressure	D-13	1
Sensor - Boost Pressure	E-13	16	Switch - Fuel Priming Pump	B-11	1
Sensor - Coolant Temperature	E-13	17	Switch - Ground Level Shutdown	G-13	6
Sensor - Front Axle Oil Temperature	I-2	18	Switch - Hood Actuator	G-13	6
Sensor - Fuel Pressure	D-13	1	Switch - Hydraulic Filter Bypass Pressure	D-5	33
Sensor - Hydraulic Oil Temperature	H-4	19	Switch - Park Brake Pressure	D-5	34
Sensor - Intake Manifold Air Temp	E-13	16	Switch - Primary Steering Pressure	I-7	5
Sensor - Lift Cylinder Head End Pressure	J-2	20	Switch - Secondary Steering Pressure	I-7	5
Sensor - Lift Position	G-2	20	Switch - Trans Filter Bypass	D-5	33

Check Part Numbers in the Parts Manuals for your Specific Machine

CONNECTOR LOCATION

Volume 1 of 2 - CHASSIS



Connector Number	Schematic Location	Machine Location
CONN 1	D-14, E-14	2
CONN 2	D-14, E-14	2
CONN 3	J-14	35
CONN 4	J-14	35
CONN 5	D-12	16
CONN 6	D-12	16
CONN 7	F-12	1
CONN 8	J-10	6
CONN 9	C-9	36
CONN 10	E-8	37
CONN 11	F-8	13
CONN 12	F-8	13
CONN 13	I-7	5
CONN 14	D-6	38
CONN 15	D-6	34
CONN 16	H-5	39
CONN 17	H-5	39
CONN 18	G-5	39
CONN 19	F-5	39
CONN 20	I-3	40
CONN 21	I-2, G-2	41
CONN 22	I-2, H-2, F-2	22
CONN 23	J-2	42
CONN 24	F-2	20
CONN 25	F-2, I-2	20
CONN 26	G-2	43

The connectors shown in this chart are for harness to harness connectors. Connectors that join a harness to a component are generally located at or near the component. See the Component Location Chart.

COMPONENT LOCATION

Volume 2 of 2 - CAB



Component	Schematic Location	Machine Location	Component	Schematic Location	Machine Location
Alarm - Action	E-15	45	Switch - Auto/Manual Gear Select	D-4	46
Alarm - Implement Audible Alert	E-15	45	Switch - Autodig Kickout Set	C-1	46
Alarm - Quick Coupler	D-1	46	Switch - Autodig Mode	D-3	46
Arc Suppressor - Forward Horn	I-7	47	Switch - Autodig Mode Select	C-1	46
Control - Dimmer	D-15	45	Switch - Autodig Trigger	G-7	47
Control - Implement	F-14	49	Switch - Beacon	G-3	52
Control - Payload Control System	D-7	50	Switch - Blower Fan Speed	D-6	48
Control - Transmission Control	L-18	51	Switch - Bucket/Fork Select	E-2	46
Converter - Voltage (10A)	F-15, G-16	51	Switch - Cat Mon Sys Mode Select	C-6	48
Diode - Blower Motor	K-15	51	Switch - Dimmer	H-1	57
Display - Groeneveld Autolube	F-6	48	Switch - Downshift	F-7	47
Flasher - 24V	E-15	45	Switch - Fine Modulation	F-8	47
Fuse - Block	B-15	45	Switch - Forward Horn	I-3	58
Fuse - Thermal Cut Out	K-15	51	Switch - Forward Horn 2	G-7	47
Guage - Quad	J-1	52	Switch - Front Intermittent Wiper/Washer	D-5	48
Indicator - Center Dash	K-1	52	Switch - Hazard Lamp	H-3	52
Indicator - Left Hand Panel	K-1	52	Switch - Heated Mirror	E-2	46
Indicator - Right Hand Panel	K-1	52	Switch - HID Lamp	J-3	52
Joystick - Implement Control	I-7	47	Switch - HVAC Select	D-6	48
Keypad - WLPCS	C-7	50	Switch - HVAC Temperature Select	D-5	48
Monitor	E-7	48	Switch - Implement Lockout	G-8	47
Motor - Blend Door Actuator	L-15	51	Switch - Key Start	G-3	52
Motor - Blower	L-16	51	Switch - Lift Tilt Kickout Set	E-1	46
Motor - Front Wiper	I-1	53	Switch - Neutral Override	C-2	46
Motor - Rear Wiper	K-14	54	Switch - Quick Coupler	D-1	46
Product Link	J-11	51	Switch - Rear Wiper/Washer	E-4	46
Radio - Product Link	K-11	51	Switch - Remote FNR	H-7	47
Relay - Axle Cooler	C-15	45	Switch - Reversing Fan	D-1	46
Relay - Forward Cab Floodlamp	C-15	45	Switch - Ride Control	C-2	46
Relay - Forward Horn	C-15	45	Switch - Running Lamp	K-3	52
Relay - Heated Mirrors Timer	D-15	45	Switch - Secondary Steering Test	D-2	46
Relay - Rear Floodlamp	C-15	45	Switch - Stop Lamp	H-1	55
Resistor A/C (1)	L-14	45	Switch - Third Function Control Flow	K-3	52
Resistor A/C (2)	L-14	45	Switch - Third Function Diverter	G-8	47
Resistor - Blower Motor	K-16	51	Switch - Transmission Gear Selector	I-3	58
Resistor - CAN A	K-6	52	Switch - Transmission Shifter Assembly	H-2	58
Sensor - 3rd Lever Position	F-7	47	Switch - Turn Signal	I-2	58
Sensor - Left Hand Brake Pedal	H-1	55	Switch - Variable Shift Control	D-3	46
Sensor - Lift Lever Position	G-7	47	Tach/Speedometer	J-1	52
Sensor - Throttle Position	G-1	56	Thermostat	K-15	51
Sensor - Tilt Lever Position	G-7	47			

Check Part Numbers in the Parts Manuals for your Specific Machine

CONNECTOR LOCATION

Volume 2 of 2 - CAB



Connector Number	Schematic Location	Machine Location
CONN 16	E-18	54
CONN 17	D-18	59
CONN 18	C-18	54
CONN 19	B-18	54
CONN 27	F-15	45
CONN 28	E-15	45
CONN 29	L-13	51
CONN 30	H-12	51
CONN 31	H-9, I-9	47
CONN 32	G-9, I-9	47
CONN 33	F-9	45
CONN 34	D-8	48
CONN 35	L-7	60
CONN 36	L-7	61
CONN 37	K-7	60
CONN 38	K-7	62
CONN 39	D-7	63
CONN 40	I-3	52
CONN 41	I-3	52
CONN 42	H-3	58
CONN 43	F-3	52
CONN 44	F-2	52
CONN 45	H-1	57
CONN 46	G-1	55

CID / MID / FMI

Volume 1 of 2 - CHASSIS



Component Identifiers (CID¹) Module Identifier (MID²) Engine Control System (MID No. 036)

CID	Component
0001	Fuel Injector Solenoid #1
0002	Fuel Injector Solenoid #2
0003	Fuel Injector Solenoid #3
0004	Fuel Injector Solenoid #4
0005	Fuel Injector Solenoid #5
0006	Fuel Injector Solenoid #6
0041	ECM 8V DC Supply
0042	Injector Actuation Valve
0091	Throttle Sensor
0094	Fuel Pressure Sensor
0100	Oil Pressure Sensor
0110	Engine Coolant Temperature Sensor
0164	Injector Actuation Pressure Sensor
0168	Electrical Power Supply
0172	Intake Manifold Air Temperature Sensor
0190	Engine Speed Sensor
0253	Personality Module
0261	Engine Speed Sensor
0262	5 Volt Sensor Supply
0267	Engine Shutdown Switch
0268	Check Programmable Parameters
0269	Sensor Power Supply
0274	Atmospheric Pressure Sensor
0275	Right Turbo Inlet Pressure Sensor
0283	Filter Restrict Lamp
0291	Engine Cooling Fan Solenoid
0296	Transmission ECM
0342	Camshaft Position Sensor
0596	Implement Control
1639	Machine Security System
1785	Intake Manifold Pressure Sensor

¹ The CID is a diagnostic code that indicates which circuit is faulty.

² The MID is a diagnostic code that indicates which electronic control module diagnosed the fault.

Event Codes Engine Control

Event Code	Condition
E096	High Fuel Pressure
E172	High Air Filter Restriction
E194	High Exhaust Temperature
E198	Low Fuel Pressure
E360	Low Engine Oil Pressure
E361	High Engine Coolant Temperature
E362	Engine Overspeed
E390	Fuel Filter Restriction
E441	Idle Elevated to Increase Battery Voltage
E539	High Intake Manifold Air Temperature

Failure Mode Identifiers (FMI)¹

FMI No.	Failure Description
0	Data valid but above normal operational range.
1	Data valid but below normal operational range.
2	Data erratic, intermittent, or incorrect.
3	Voltage above normal or shorted high.
4	Voltage below normal or shorted low.
5	Current below normal or open circuit.
6	Current above normal or grounded circuit.
7	Mechanical system not responding properly.
8	Abnormal frequency, pulse width, or period.
9	Abnormal update.
10	Abnormal rate of change.
11	Failure mode not identifiable.
12	Bad device or component.
13	Out of calibration.
14	Parameter failures.
15	Parameter failures.
16	Parameter not available.
17	Module not responding.
18	Sensor supply fault.
19	Condition not met.
20	Parameter failures.

¹The FMI is a diagnostic code that indicates what type of failure has occurred.

CID / MID / FMI

Volume 2 of 2 - CAB



Failure Mode Identifiers (FMI) ¹	
FMI No.	Failure Description
0	Data valid but above normal operational range.
1	Data valid but below normal operational range.
2	Data erratic, intermittent, or incorrect.
3	Voltage above normal or shorted high.
4	Voltage below normal or shorted low.
5	Current below normal or open circuit.
6	Current above normal or grounded circuit.
7	Mechanical system not responding properly.
8	Abnormal frequency, pulse width, or period.
9	Abnormal update.
10	Abnormal rate of change.
11	Failure mode not identifiable.
12	Bad device or component.
13	Out of calibration.
14	Parameter failures.
15	Parameter failures.
16	Parameter not available.
17	Module not responding.
18	Sensor supply fault.
19	Condition not met.
20	Parameter failures.

¹The FMI is a diagnostic code that indicates what type of failure has occurred.

Electronic Implement Control (MID No. 082)	
CID	Component
0041	8 Volt DC Supply
0168	Electrical System Voltage
0268	Programmed Parameter Fault
0296	Transmission Control
0350	Lift Linkage Position Sensor
0351	Tilt Linkage Position Sensor
0352	Lift Lever Position Sensor
0353	Tilt Lever Position Sensor
0354	Raise Solenoid
0355	Lower Solenoid
0356	Dump Solenoid
0357	Rackback Solenoid
0358	Pilot Pressure Solenoid
0364	Lift Cylinder Head End Oil Pressure Sensor
0365	Kickout Set Switch
0487	3rd Lever Position Sensor
0490	Implement Lockout Switch
0491	3rd Function Forward Solenoid
0492	3rd Function Rearward Solenoid
0562	Caterpillar Monitoring System
0590	Engine Electronic Control Module
0965	Autodig Dig Mode Switch
0967	Machine Application
1187	Continuous Flow Rocker Switch
1324	Autodig Operation Mode Select Switch
1325	Autodig Trigger Switch
1326	ECM Location Code
1592	Autodig Kickout Set Switch
1639	Machine Security System ECM
1718	Fine Modulation Switch
2326	Lower Anti-Drift Solenoid Valve
2328	Dump Anti-Drift Solenoid Valve

Product Link Radio (MID No. 122)	
CID	Component
0168	Electrical System Voltage
0254	Electronic Control Module
0269	Sensor Power Supply
1250	Remote Communication Module
1251	Alternator "R" Terminal

Component Identifiers (CID) ¹ Module Identifier (MID) ² Caterpillar Monitoring System (MID No. 030)	
CID	Component
0096	Fuel Level Sender
0100	Engine Oil Pressure Sensor
0110	Engine Coolant Temperature Sensor
0177	Torque Converter Oil Temperature Sensor
0248	Data Link
0263	Sensor Power Supply
0271	Action Alarm
0324	Action Lamp
0600	Hydraulic Oil Temperature Sensor
0819	Display Data Link
0821	Display Power Supply
0826	T/C Oil Temperature Sensor
0830	Brake Oil Temperature Sensor

Payload Control System (MID No. 074)	
CID	Component
0248	CAT Data Link
0364	Head End Lift Cylinder Pressure Sensor
0591	PCS EEPROM
0769	Rod End Lift Cylinder Pressure Sensor
1964	Lift Position Sensor

Electronic Transmission Control System (MID No. 081)	
CID	Component
0041	8 Volt DC Supply
0168	Electrical System Voltage
0177	Transmission Oil Temperature Sensor
0190	Engine Speed Sensor
0262	5 Volt DC Supply
0268	Programmed Parameter Fault
0367	Ride Control Switch
0368	Transmission Auto/Manual Switch
0444	Start Relay
0562	Electronic Monitoring System
0585	Transmission Output Speed Sensor 1
0590	Engine Control Module
0596	Implement Control
0623	Directional Switch
0627	Parking Brake Pressure Sw.
0672	Transmission Input Speed Sensor
0673	Transmission Output Speed Sensor 2
0702	Lever Switch (Transmission Shifting/Direction)
0737	Left Brake Pedal Position Sensor
0793	Primary Steering Pressure Switch
0794	Secondary Steering Pressure Switch
0795	Secondary Steering Relay
0967	Machine Application
1326	ECM Location Code
1400	Rear Axle Oil Cooler Solenoid
1401	Reverse Solenoid
1402	Forward Solenoid
1403	Fourth Speed Clutch
1404	Third Speed Clutch
1405	Second Speed Clutch
1406	First Speed Clutch
1521	Part-Throttle Autoshift Selector Switch
1960	Ignition Key Reader
2129	Ride Control Solenoid (1)
2274	Transmission Direction Switch #2
2347	Ride Control Solenoid (2)
2684	Ride Control Solenoid (3)

Machine Security System (MID No. 124)	
CID	Component
0168	Electrical System Voltage
0248	Data Link
0817	ECM Internal Backup Battery
1391	Theft Deterent Output Driver #1
1392	Theft Deterent Output Driver #2

¹ The CID is a diagnostic code that indicates which circuit is faulty.

² The MID is a diagnostic code that indicates which electronic control module diagnosed the fault.

HARNESS and WIRE

Electrical Schematic Symbols



Symbols

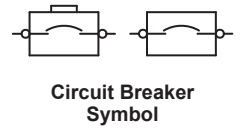
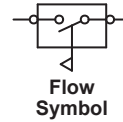
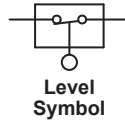
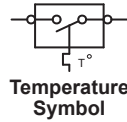
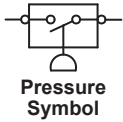

Symbols and Definitions



Fuse: A component in an electrical circuit that will open the circuit if too much current flows through it.

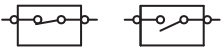

Switch (Normally Open): A switch that will close at a specified point (temp, press, etc.). The circle indicates that the component has screw terminals and a wire can be disconnected from it.

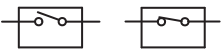

Switch (Normally Closed): A switch that will open at a specified point (temp, press, etc.). No circle indicates that the wire cannot be disconnected from the component.

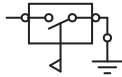

Ground (Wired): This indicates that the component is connected to a grounded wire. The grounded wire is fastened to the machine.

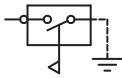

Ground (Case): This indicates that the component does not have a wire connected to ground. It is grounded by being fastened to the machine.



Reed Switch: A switch whose contacts are controlled by a magnet. A magnet closes the contacts of a normally open reed switch; it opens the contacts of a normally closed reed switch.

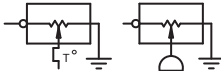

Sender: A component that is used with a temperature or pressure gauge. The sender measures the temperature or pressure. Its resistance changes to give an indication to the gauge of the temperature or pressure.

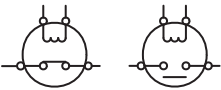

Relay (Magnetic Switch): A relay is an electrical component that is activated by electricity. It has a coil that makes an electromagnet when current flows through it. The electromagnet can open or close the switch part of the relay.

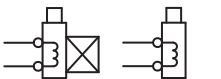

Solenoid: A solenoid is an electrical component that is activated by electricity. It has a coil that makes an electromagnet when current flows through it. The electromagnet can open or close a valve or move a piece of metal that can do work.

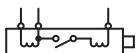

Magnetic Latch Solenoid: A magnetic latch solenoid is an electrical component that is activated by electricity and held latched by a permanent magnet. It has two coils (latch and unlatch) that make electromagnet when current flows through them. It also has an internal switch that places the latch coil circuit open at the time the coil latches.

Harness and Wire Symbols

Wire, Cable, or Harness Assembly Identification: Includes Harness Identification Letters and Harness Connector Serialization Codes (see sample).

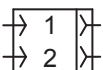
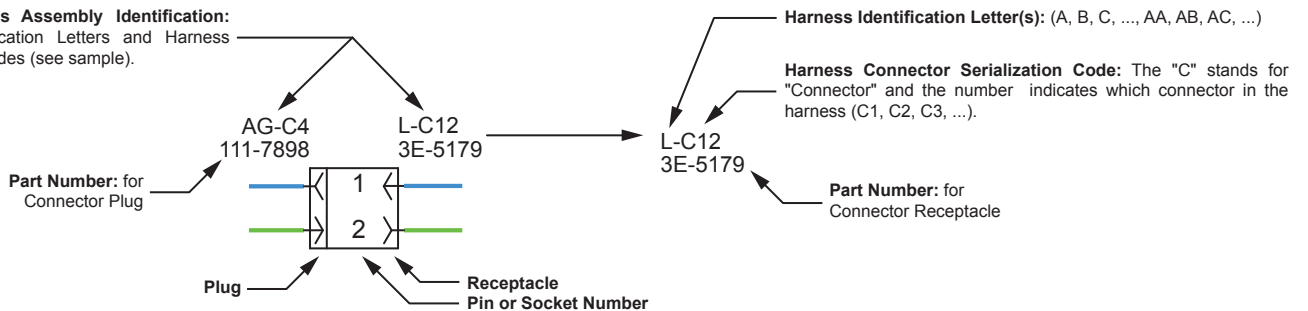

Deutsch connector: Typical representation of a Deutsch connector. The plug contains all sockets and the receptacle contains all pins.

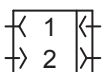

Sure-Seal connector: Typical representation of a Sure-Seal connector. The plug and receptacle contain both pins and sockets.

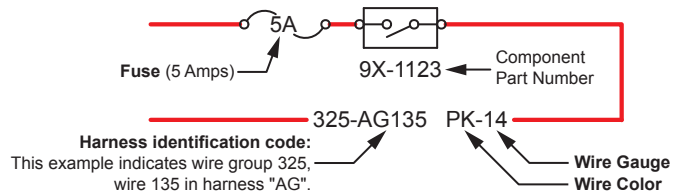

SPECIFICATIONS AND RELATED MANUALS

Volume 1 of 2 - CHASSIS



Related Electrical Service Manuals	
Title	Form Number
Cross Reference for Electrical Connectors:	REHS0970
Alternator: 177-9953 197-8820	SENR4130
Electric Starting Motor: 207-1517	SENR3581
Engine Control:	RENR9319

Off Machine Switch Specification				
Part No.	Function	Actuate	Deactuate	Contact Position
114-5333	A/C (High / Low) Pressure	275 to 1750 kPa ¹ (39.9 to 253.8 psi)	170 ± 55 kPa (25 ± 8 psi)	Normally Open ²
117-7773	Hydraulic Filter Bypass Pressure	138 ± 28 kPa (20 ± 4 psi)	89 ± 20 kPa (12.9 ± 2.9 psi)	Normally Closed
174-4312	Park Brake Pressure	8270 kPa MAX (1200 psi MAX)	6890 ± 345 kPa (1000 ± 50 psi)	A-B, Normally Open A-C, Normally Closed
175-3244	Brake Oil Pressure	10700 kPa MAX (1552 psi MAX)	8960 ± 537 kPa (1300 ± 79 psi)	A-B, Normally Open A-C, Normally Closed
230-5771	Primary Steering Pressure Secondary Steering Pressure	1200 kPa MAX (174.0 psi MAX)	700 ± 100 kPa (102 ± 14.5 psi)	A-B Normally Open A-C Normally Closed
258-0883	Fuel Differential Pressure	110.3 ± 13.8 kPa (16 ± 2 psi)	69 kPa MIN (10 psi MIN)	Normally Closed

¹ With increasing pressure the closed condition can be maintained up to 2800 kpa (405 psi), with decreasing pressure the closed condition can be maintained down to 170 kpa (25psi).

² Contact position at the contacts of the harness connector.

Resistor, Sender and Solenoid Specifications		
Part No.	Component Description	Resistance (Ohms) ¹
134-2540	Resistor: CAN Data Link	120 ± 12
145-7028	Sender: T/C Temperature	1250
148-2350	Solenoid: Variable Speed Fan	5.0 ± 0.3
163-0872	Solenoid: A/C Compressor Clutch	17.6±0.6
183-7595	Solenoid: Axle Cooler Clutch	5.0 ± 0.3
225-0300	Solenoid: Pilot Hydraulic Supply	38.12 ± 1.9
241-5895	Solenoid: Auto/Reverse Fan	33.75 ± 1.69
245-4659	Sender: Fuel Level	Empty: 240 - 250 Full: 28 - 33
244-3114	Solenoid: Transmission Clutch	8.7 ± 0.4
239-1134	Solenoid: Start Aid	20.0
262-5265	Solenoid: Dump Anti-Drift Lower Anti-Drift Ride Control 3	33.8
285-5730	Solenoid: Aux 3rd Function Forward Aux 3rd Function Rearward Dump Prop Racback Prop Raise Prop	5.0 ± 0.3

¹ At room temperature unless otherwise noted.

SPECIFICATIONS AND RELATED MANUALS

Volume 2 of 2 - CAB



Related Electrical Service Manuals	
Title	Form Number
Cross Reference for Electrical Connectors:	REHS0970
Machine Security System:	REN2462
Product Link Radio:	REN7911
Power Train Control:	REN8846
Implement Control:	REN8858
Caterpillar Monitoring System:	SEN1394
Payload Control System:	REN6293

Off Machine Switch Specification				
Part No.	Function	Actuate	Deactuate	Contact Position
3E-5464	A/C Thermostat	-1.1 ± 0.8°C (30 ± 1.4°F)	2.2 ± 0.8°C (36 ± 1.4°F)	Normally Closed

Resistor, Sender and Solenoid Specifications		
Part No.	Component Description	Resistance (Ohms) ¹
9G-1950	Resistor: Blower Motor Speed	Overall: 2.0 ± 0.1 Tap 1.0 ± .05
134-2540	Resistor: CAN	120 ± 12

¹ At room temperature unless otherwise noted.

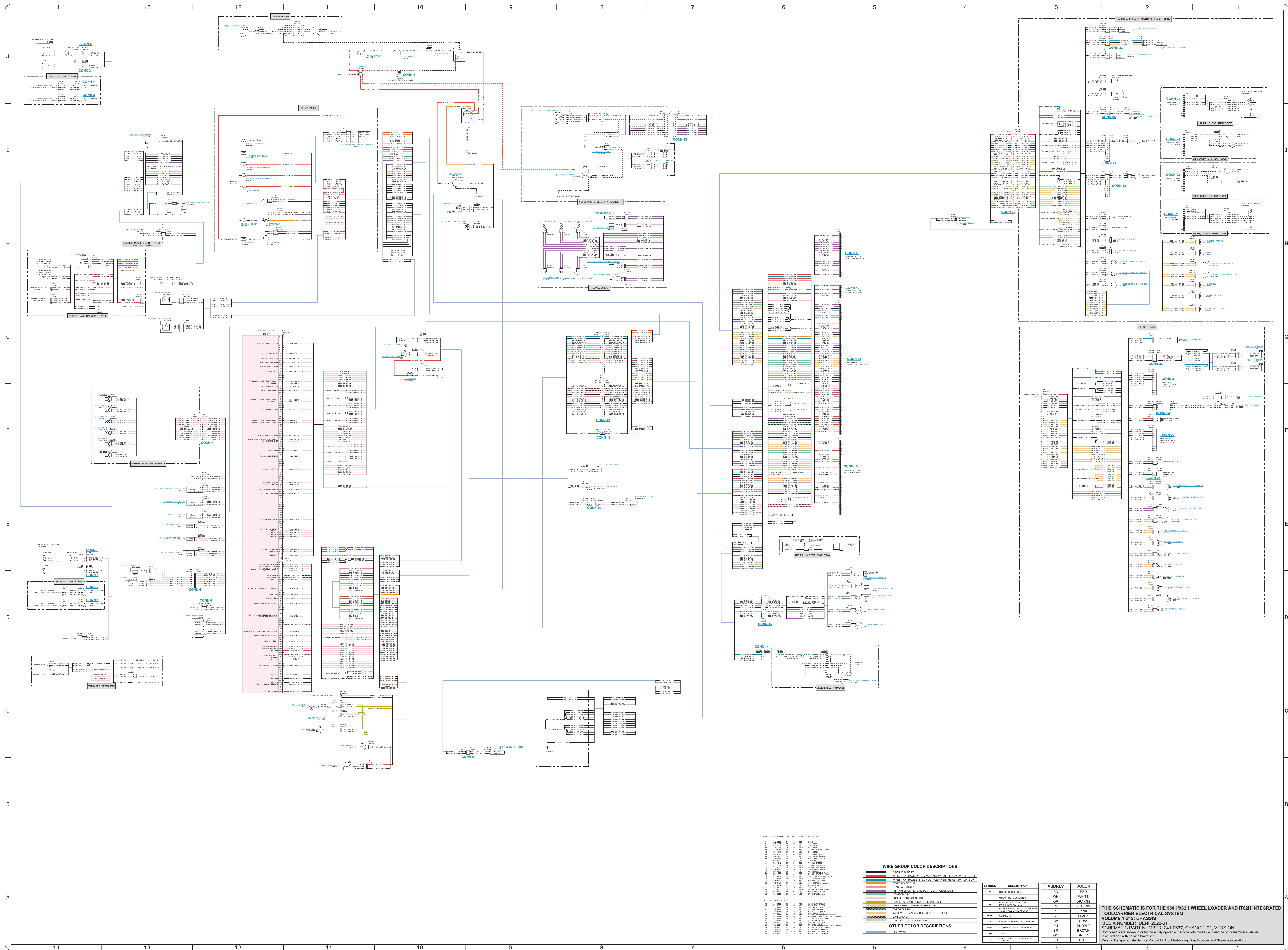

WIRE GROUP COLOR DESCRIPTIONS

WIRE GROUP	DESCRIPTION
W1	IGNITION CIRCUIT
W2	WIRES THAT HAVE SYSTEM VOLTAGE WHEN THE KEY SWITCH IS OFF
W3	WIRES THAT HAVE SYSTEM VOLTAGE WHEN THE KEY SWITCH IS ON
W4	STARTING CIRCUIT
W5	STARTING CIRCUIT
W6	STARTING CIRCUIT
W7	STARTING CIRCUIT
W8	STARTING CIRCUIT
W9	STARTING CIRCUIT
W10	STARTING CIRCUIT
W11	STARTING CIRCUIT
W12	STARTING CIRCUIT
W13	STARTING CIRCUIT
W14	STARTING CIRCUIT
W15	STARTING CIRCUIT
W16	STARTING CIRCUIT
W17	STARTING CIRCUIT
W18	STARTING CIRCUIT
W19	STARTING CIRCUIT
W20	STARTING CIRCUIT
W21	STARTING CIRCUIT
W22	STARTING CIRCUIT
W23	STARTING CIRCUIT
W24	STARTING CIRCUIT
W25	STARTING CIRCUIT
W26	STARTING CIRCUIT
W27	STARTING CIRCUIT
W28	STARTING CIRCUIT
W29	STARTING CIRCUIT
W30	STARTING CIRCUIT
W31	STARTING CIRCUIT
W32	STARTING CIRCUIT
W33	STARTING CIRCUIT
W34	STARTING CIRCUIT
W35	STARTING CIRCUIT
W36	STARTING CIRCUIT
W37	STARTING CIRCUIT
W38	STARTING CIRCUIT
W39	STARTING CIRCUIT
W40	STARTING CIRCUIT
W41	STARTING CIRCUIT
W42	STARTING CIRCUIT
W43	STARTING CIRCUIT
W44	STARTING CIRCUIT
W45	STARTING CIRCUIT
W46	STARTING CIRCUIT
W47	STARTING CIRCUIT
W48	STARTING CIRCUIT
W49	STARTING CIRCUIT
W50	STARTING CIRCUIT
W51	STARTING CIRCUIT
W52	STARTING CIRCUIT
W53	STARTING CIRCUIT
W54	STARTING CIRCUIT
W55	STARTING CIRCUIT
W56	STARTING CIRCUIT
W57	STARTING CIRCUIT
W58	STARTING CIRCUIT
W59	STARTING CIRCUIT
W60	STARTING CIRCUIT
W61	STARTING CIRCUIT
W62	STARTING CIRCUIT
W63	STARTING CIRCUIT
W64	STARTING CIRCUIT
W65	STARTING CIRCUIT
W66	STARTING CIRCUIT
W67	STARTING CIRCUIT
W68	STARTING CIRCUIT
W69	STARTING CIRCUIT
W70	STARTING CIRCUIT
W71	STARTING CIRCUIT
W72	STARTING CIRCUIT
W73	STARTING CIRCUIT
W74	STARTING CIRCUIT
W75	STARTING CIRCUIT
W76	STARTING CIRCUIT
W77	STARTING CIRCUIT
W78	STARTING CIRCUIT
W79	STARTING CIRCUIT
W80	STARTING CIRCUIT
W81	STARTING CIRCUIT
W82	STARTING CIRCUIT
W83	STARTING CIRCUIT
W84	STARTING CIRCUIT
W85	STARTING CIRCUIT
W86	STARTING CIRCUIT
W87	STARTING CIRCUIT
W88	STARTING CIRCUIT
W89	STARTING CIRCUIT
W90	STARTING CIRCUIT
W91	STARTING CIRCUIT
W92	STARTING CIRCUIT
W93	STARTING CIRCUIT
W94	STARTING CIRCUIT
W95	STARTING CIRCUIT
W96	STARTING CIRCUIT
W97	STARTING CIRCUIT
W98	STARTING CIRCUIT
W99	STARTING CIRCUIT
W100	STARTING CIRCUIT

OTHER COLOR DESCRIPTIONS

SYMBOL	DESCRIPTION	ABBREV	COLOR
RD	CIRCUIT CONNECTED	RD	RED
WH	CIRCUIT NOT CONNECTED	WH	WHITE
OR	ELECTRICAL CONNECTION TO BATTERY STALL/CLIP	OR	ORANGE
YL	ELECTRICAL CONNECTION TO BATTERY STALL/CLIP	YL	YELLOW
PK	ELECTRICAL CONNECTION TO BATTERY STALL/CLIP	PK	PINK
BLK	ELECTRICAL CONNECTION TO BATTERY STALL/CLIP	BLK	BLACK
GY	ELECTRICAL CONNECTION TO BATTERY STALL/CLIP	GY	GRAY
PUR	ELECTRICAL CONNECTION TO BATTERY STALL/CLIP	PUR	PURPLE
BRN	ELECTRICAL CONNECTION TO BATTERY STALL/CLIP	BRN	BROWN
GRN	ELECTRICAL CONNECTION TO BATTERY STALL/CLIP	GRN	GREEN
BLU	ELECTRICAL CONNECTION TO BATTERY STALL/CLIP	BLU	BLUE

THIS SCHEMATIC IS FOR THE 950H/962H WHEEL LOADER AND IT62H INTEGRATED TOOL CARRIER ELECTRICAL SYSTEM
 VOLUME 1 of 2: CHASSIS
 MEDIA NUMBER: UENR228-01
 SCHEMATIC PART NUMBER: 241-0637, CHANGE: 01, VERSION: -
 Components are shown installed on a fully equipped machine with the key and engine off. Transmission shifter in neutral and with parking brake set.
 Refer to the appropriate Service Manual for Troubleshooting, Specifications and Systems Operations.

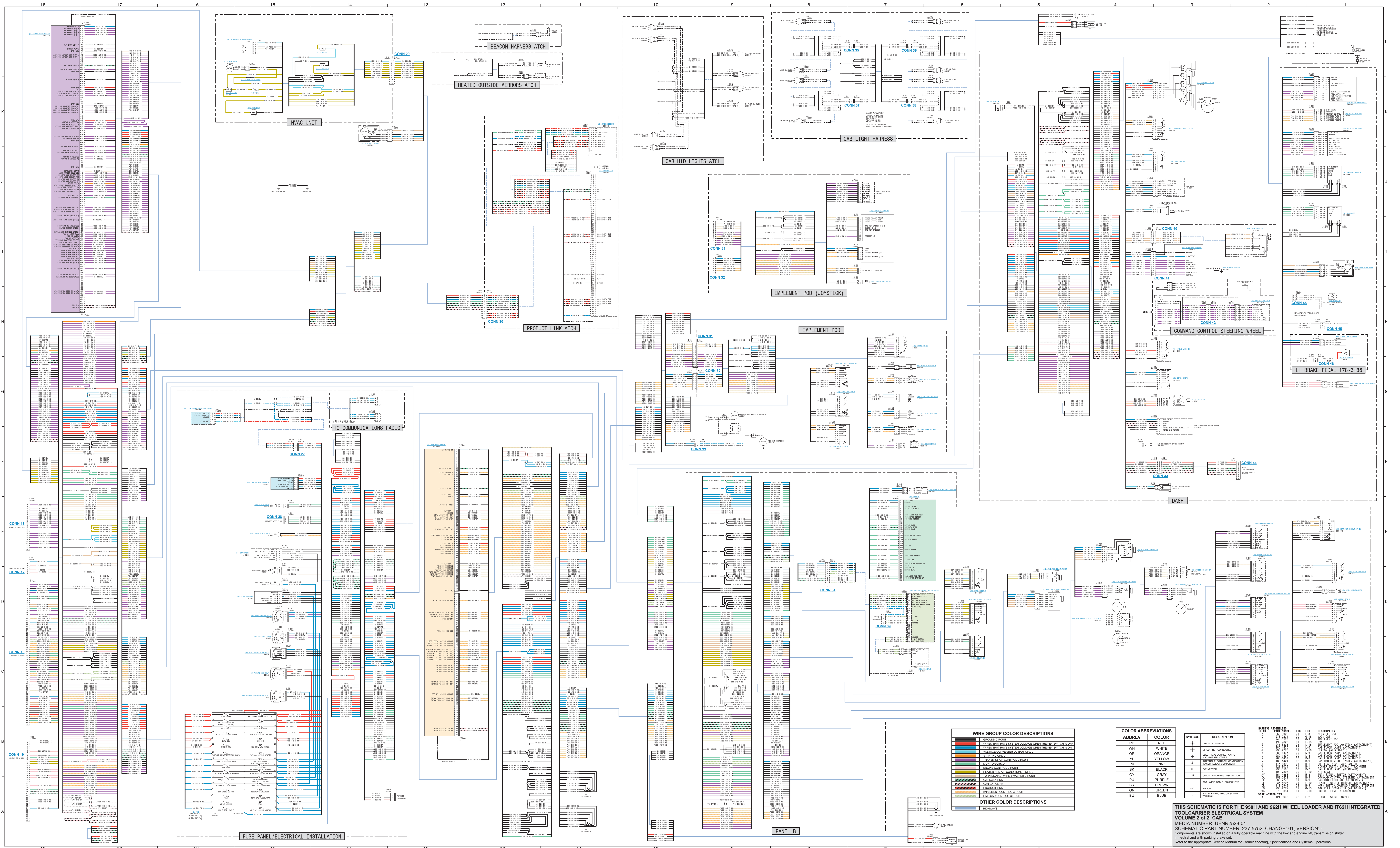

WIRE GROUP COLOR DESCRIPTIONS

GROUND CIRCUIT
WIRING THAT FEEDS SYSTEM VOL TAGS WHEN THE KEY SWITCH IS OFF
WIRING THAT FEEDS SYSTEM VOL TAGS WHEN THE KEY SWITCH IS ON
VOL TAGS CONNECTOR OUTPUT CIRCUIT
STARTING CIRCUIT
TRANSMISSION CONTROL CIRCUIT
MONITOR CIRCUIT
ENGINE CONTROL CIRCUIT
HEATING AND AIR CONDITIONING CIRCUIT
LUBRICATION OIL PRESSURE CIRCUIT
CAT DATA LINK
CON DATA LINK
PRODUCT LINK
IMPLEMENT CONTROL CIRCUIT
JOYSTICK CONTROL CIRCUIT

OTHER COLOR DESCRIPTIONS

- Lightning bolt symbol: HIGHVOLT

COLOR ABBREVIATIONS

ABBREV	COLOR	SYMBOL	DESCRIPTION
RD	RED	—	GROUP CONNECTOR
WH	WHITE	+	CIRCUIT NOT CONNECTED
GR	GRAY	+	SECURE DISCONNECT
YL	YELLOW	+	TO SUPPLY OR COMMON
PK	PINK	+	TO SUPPLY OR COMMON
BL	BLACK	+	COMMON
GV	GRAY	+	GROUP GROUND DESCRIPTION
PU	PURPLE	+	24V W/IN. LOCAL COMPRESSOR
BR	BROWN	+	SPRUE
GN	GREEN	+	BRAKE CHECK VALVE SIGNAL
BU	BLUE	+	STANDARD

REVISIONS

REV	DATE	BY	DESCRIPTION
01	01/11/01	001	REVISED FOR 950H AND 962H WHEEL LOADER AND IT62H INTEGRATED TOOLCARRIER ELECTRICAL SYSTEM
02	01/11/01	001	REVISED FOR 950H AND 962H WHEEL LOADER AND IT62H INTEGRATED TOOLCARRIER ELECTRICAL SYSTEM
03	01/11/01	001	REVISED FOR 950H AND 962H WHEEL LOADER AND IT62H INTEGRATED TOOLCARRIER ELECTRICAL SYSTEM
04	01/11/01	001	REVISED FOR 950H AND 962H WHEEL LOADER AND IT62H INTEGRATED TOOLCARRIER ELECTRICAL SYSTEM
05	01/11/01	001	REVISED FOR 950H AND 962H WHEEL LOADER AND IT62H INTEGRATED TOOLCARRIER ELECTRICAL SYSTEM
06	01/11/01	001	REVISED FOR 950H AND 962H WHEEL LOADER AND IT62H INTEGRATED TOOLCARRIER ELECTRICAL SYSTEM
07	01/11/01	001	REVISED FOR 950H AND 962H WHEEL LOADER AND IT62H INTEGRATED TOOLCARRIER ELECTRICAL SYSTEM
08	01/11/01	001	REVISED FOR 950H AND 962H WHEEL LOADER AND IT62H INTEGRATED TOOLCARRIER ELECTRICAL SYSTEM
09	01/11/01	001	REVISED FOR 950H AND 962H WHEEL LOADER AND IT62H INTEGRATED TOOLCARRIER ELECTRICAL SYSTEM
10	01/11/01	001	REVISED FOR 950H AND 962H WHEEL LOADER AND IT62H INTEGRATED TOOLCARRIER ELECTRICAL SYSTEM
11	01/11/01	001	REVISED FOR 950H AND 962H WHEEL LOADER AND IT62H INTEGRATED TOOLCARRIER ELECTRICAL SYSTEM
12	01/11/01	001	REVISED FOR 950H AND 962H WHEEL LOADER AND IT62H INTEGRATED TOOLCARRIER ELECTRICAL SYSTEM
13	01/11/01	001	REVISED FOR 950H AND 962H WHEEL LOADER AND IT62H INTEGRATED TOOLCARRIER ELECTRICAL SYSTEM
14	01/11/01	001	REVISED FOR 950H AND 962H WHEEL LOADER AND IT62H INTEGRATED TOOLCARRIER ELECTRICAL SYSTEM
15	01/11/01	001	REVISED FOR 950H AND 962H WHEEL LOADER AND IT62H INTEGRATED TOOLCARRIER ELECTRICAL SYSTEM
16	01/11/01	001	REVISED FOR 950H AND 962H WHEEL LOADER AND IT62H INTEGRATED TOOLCARRIER ELECTRICAL SYSTEM
17	01/11/01	001	REVISED FOR 950H AND 962H WHEEL LOADER AND IT62H INTEGRATED TOOLCARRIER ELECTRICAL SYSTEM
18	01/11/01	001	REVISED FOR 950H AND 962H WHEEL LOADER AND IT62H INTEGRATED TOOLCARRIER ELECTRICAL SYSTEM
19	01/11/01	001	REVISED FOR 950H AND 962H WHEEL LOADER AND IT62H INTEGRATED TOOLCARRIER ELECTRICAL SYSTEM
20	01/11/01	001	REVISED FOR 950H AND 962H WHEEL LOADER AND IT62H INTEGRATED TOOLCARRIER ELECTRICAL SYSTEM
21	01/11/01	001	REVISED FOR 950H AND 962H WHEEL LOADER AND IT62H INTEGRATED TOOLCARRIER ELECTRICAL SYSTEM
22	01/11/01	001	REVISED FOR 950H AND 962H WHEEL LOADER AND IT62H INTEGRATED TOOLCARRIER ELECTRICAL SYSTEM
23	01/11/01	001	REVISED FOR 950H AND 962H WHEEL LOADER AND IT62H INTEGRATED TOOLCARRIER ELECTRICAL SYSTEM
24	01/11/01	001	REVISED FOR 950H AND 962H WHEEL LOADER AND IT62H INTEGRATED TOOLCARRIER ELECTRICAL SYSTEM
25	01/11/01	001	REVISED FOR 950H AND 962H WHEEL LOADER AND IT62H INTEGRATED TOOLCARRIER ELECTRICAL SYSTEM
26	01/11/01	001	REVISED FOR 950H AND 962H WHEEL LOADER AND IT62H INTEGRATED TOOLCARRIER ELECTRICAL SYSTEM
27	01/11/01	001	REVISED FOR 950H AND 962H WHEEL LOADER AND IT62H INTEGRATED TOOLCARRIER ELECTRICAL SYSTEM
28	01/11/01	001	REVISED FOR 950H AND 962H WHEEL LOADER AND IT62H INTEGRATED TOOLCARRIER ELECTRICAL SYSTEM
29	01/11/01	001	REVISED FOR 950H AND 962H WHEEL LOADER AND IT62H INTEGRATED TOOLCARRIER ELECTRICAL SYSTEM
30	01/11/01	001	REVISED FOR 950H AND 962H WHEEL LOADER AND IT62H INTEGRATED TOOLCARRIER ELECTRICAL SYSTEM
31	01/11/01	001	REVISED FOR 950H AND 962H WHEEL LOADER AND IT62H INTEGRATED TOOLCARRIER ELECTRICAL SYSTEM

THIS SCHEMATIC IS FOR THE 950H AND 962H WHEEL LOADER AND IT62H INTEGRATED TOOLCARRIER ELECTRICAL SYSTEM
VOLUME 2 OF 2: CAB
 MEDIA NUMBER: UENR2528-01
 SCHEMATIC PART NUMBER: 237-5752 CHANGE: 01, VERSION: -
 Components are shown installed on a fully operable machine with the key and engine off, transmission in neutral and with parking brake set.
 Refer to the appropriate Service Manual for Troubleshooting, Specifications and System Operations.

MACHINE HARNESS CONNECTOR AND COMPONENT LOCATIONS

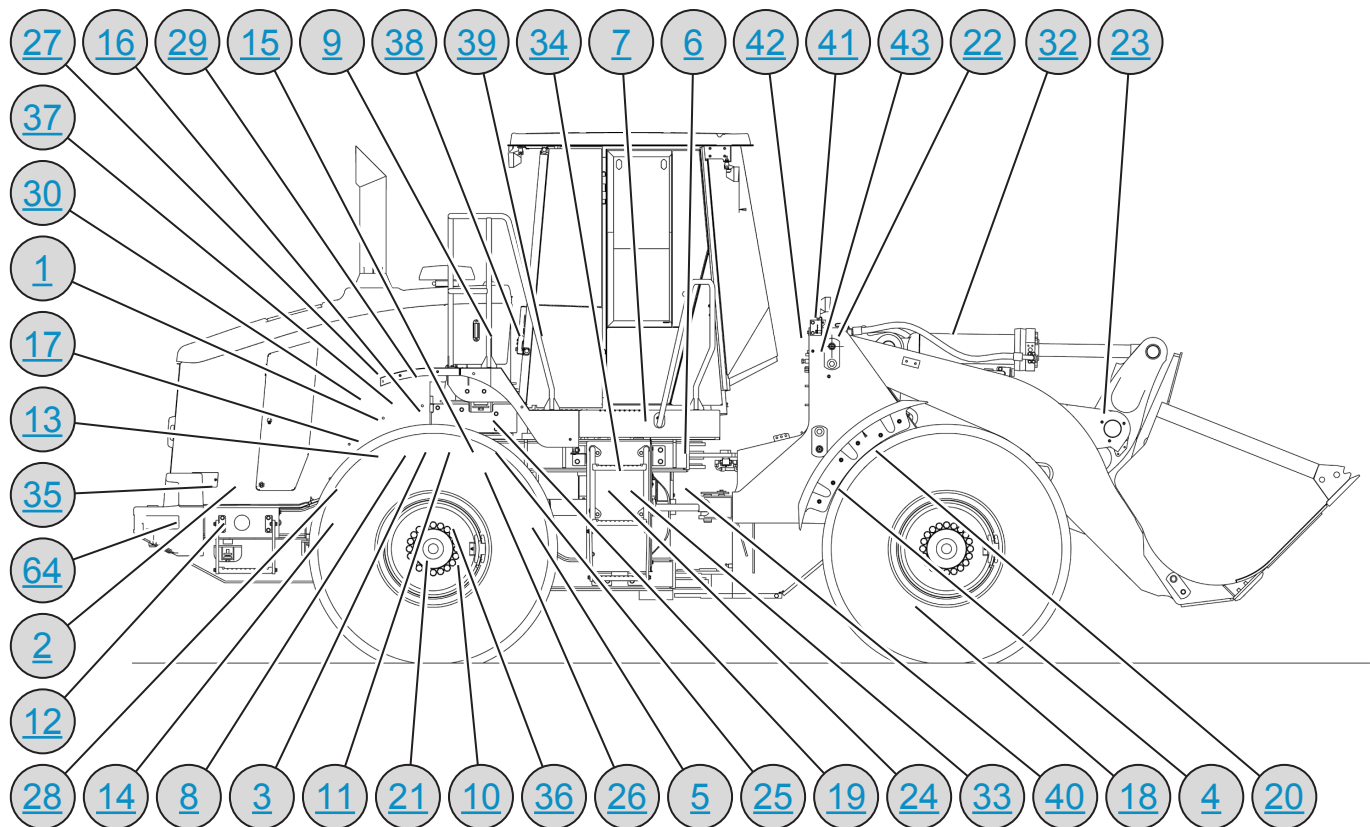
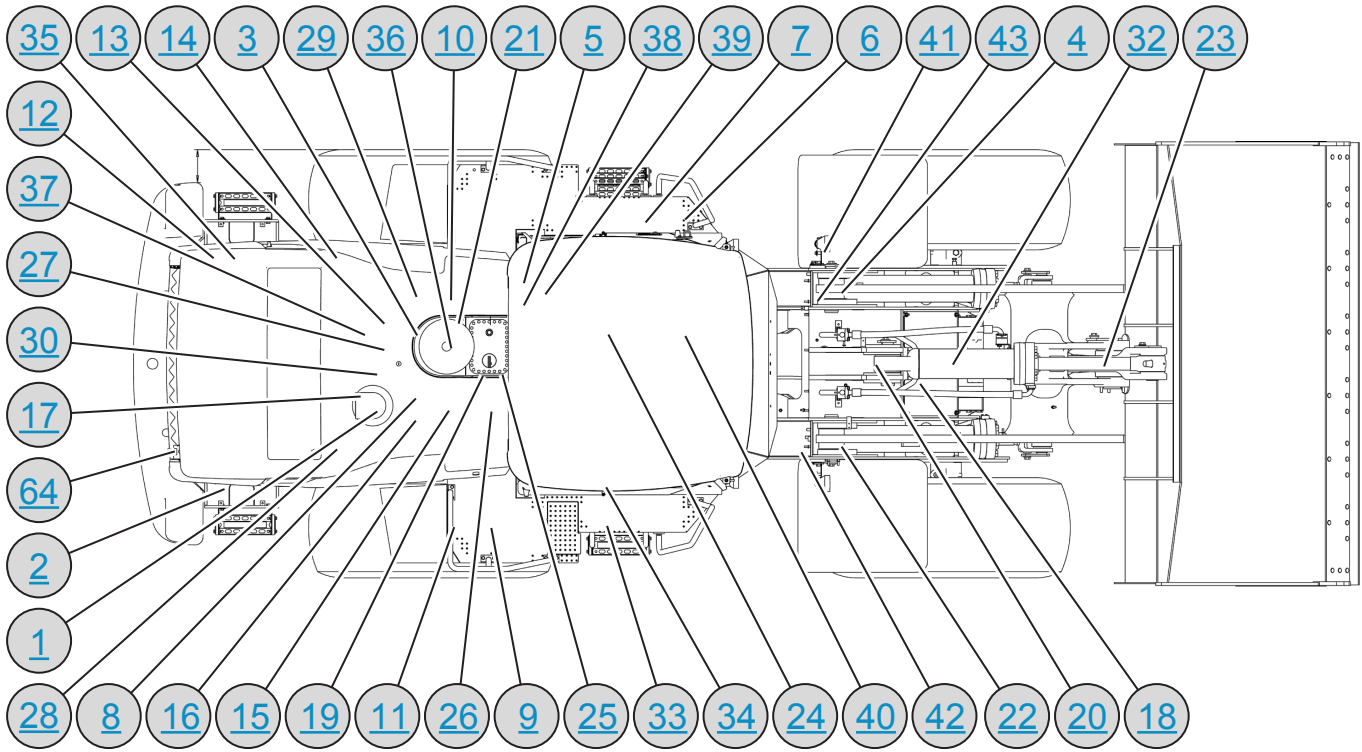

MACHINE HARNESS CONNECTOR AND COMPONENT LOCATIONS

